

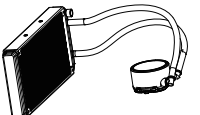

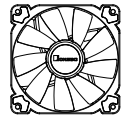







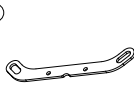

SHADOW · 360

Water Cooling Radiator Installation Manual

List of Materials

			
			
			
			
			
			
① Radiator body 1 PCS	② 120mm Fan 3 PCS	③ Fixing Plate 1 PCS	
④ Intel Buckle Strip 2 PCS	⑤ AM4 Buckle Strip 2 PCS	⑥ AM4 Mounting Screw 2 PCS	
⑦ AM4 Mounting Nut 2 PCS	⑧ M3.0 Mounting Screw 4 PCS	⑨ M4.0 Mounting Screw 4 PCS	
⑩ Fan Screw 12 PCS	⑪ Fixing Plate Screw 4 PCS	⑫ Case Screw 12 PCS	
⑬ Thermal Silicone Grease 1 PCS Scoop for Smearing Silicone Grease 1 PCS	⑭ Controller 1 PCS	⑮ Motherboard sync cable 1 PCS	
⑯ Fan Y-type adapter cable 1 PCS	⑰ Fixing Foam 1 PCS		

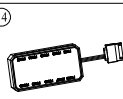
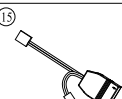
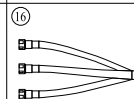
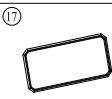
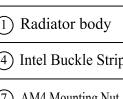
Remote Control Manual

Rainbow Mode

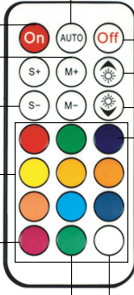

- Turn on the light
- M+: Mode+ / M-: Mode- → Light brightness +
- Fan speed control (For extended fans): Stop, Medium Speed, High Speed / S+: Speed+ / S-: Speed- → Light brightness -
- Static monochrome button: Displaying different colors with corresponding buttons
- Color correction settings: Press the OFF button to turn off the light. Long press AUTO for 3 seconds. Press button number 3 to switch (The first three sequential colors are red, green and blue). Press the OFF button to exit saving.
- Long press for 5 seconds – One to one match between Control box and Remote control
- Long press for 5 seconds – Switch between Remote control mode / Motherboard control mode
- Long press for 5 seconds – One to one match between Control box and Remote control is removed

01、Tear protection film from copper base / brush the silicone grease

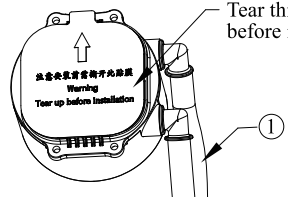

Tear this film before installation

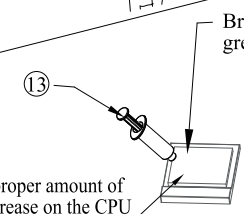

Brush silicone grease equably

Apply a proper amount of silicone grease on the CPU

Instructions:

- Tear the PE film from the copper base of water cooler
- Apply a proper amount of silicone grease on the CPU and brush it equably with silicone grease scoop

02、Buckle strip installation

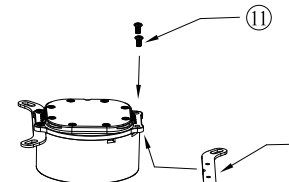
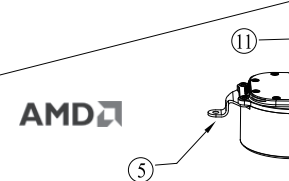
Instructions:

Heading up the copper, place the fixing plates into slots and lock with fixing plate screws.

Controller Connection Instruction



FAN1-FAN10 Connect to luminous device

Power IN: 5V & 12V Connect to SATA power supply

Data GND Connect to motherboard sync socket

03、Lock to motherboard

AM4 Motherboard Installation

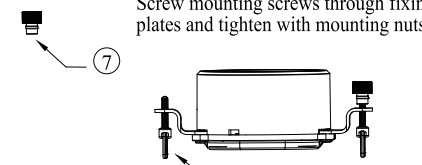

Screw mounting screws through fixing plates and tighten with mounting nuts

Motherboard

Screw mounting screws into motherboard and tighten with mounting nuts

Intel Motherboard Series Installation

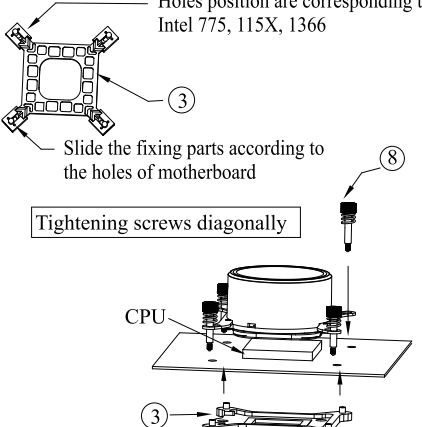

Holes position are corresponding to Intel 775, 115X, 1366

Slide the fixing parts according to the holes of motherboard

Tightening screws diagonally

CPU

- Align fixing plate to the mounting holes and fix it on the motherboard
- Align holes of fixing plate and lock with fixing plate screws

Intel 2011 Motherboard Installation

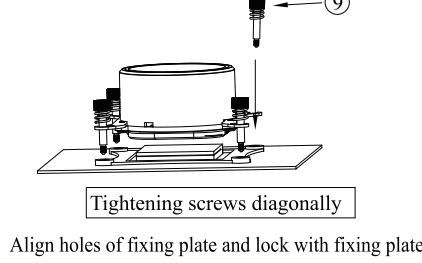

Tightening screws diagonally

Align holes of fixing plate and lock with fixing plate screws

04、Instructions for Pump and Fan Cables Connection

- Connect the 3PIN interface of the pump to the motherboard AIO/PUMP socket.
- Connect 4PIN PWM power supply wire to the motherboard CPU FAN socket through Y-type adapter cable.
- Connect 6PIN leadwire of fan and pump to number 1-10 controller socket.
- Connect controller SATA power supply connector to PSU SATA power supply port.
- Stick controller with magnet/3M sticker at back to computer case
- Control light effect with remote control

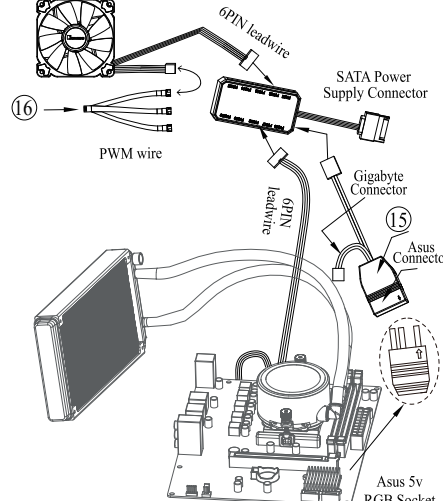

6PIN leadwire

SATA Power Supply Connector

PWM wire

Gigabyte Connector

Asus Connector

Asus 5v RGB Socket

Motherboard synchronization instructions:

If you want to synchronize the light effect with motherboard, after connecting the motherboard sync cable to the controller, the other side plug in motherboard 5V RGB socket (please note the difference between Gigabyte/Asus sockets), press and hold number 11 button for 5 seconds, switch to motherboard control, press 5 seconds again for switching back to controller control.

05、Lock Radiator and fan to computer case

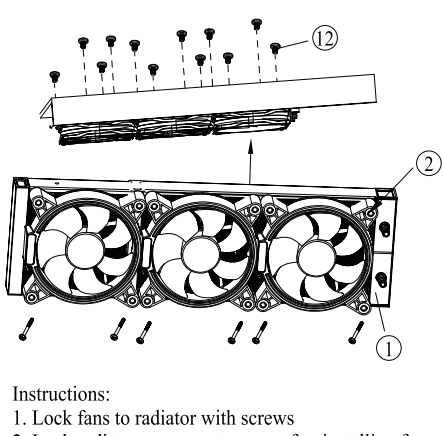

Instructions:

- Lock fans to radiator with screws
- Lock radiator to computer case after installing fans