

U1 PLUS Manual / 说明书

Specification / 产品规格:

Model/型号: U1 PLUS

Color/颜色: Silver / Black / Red / Blue
银色 / 黑色 / 红色 / 蓝色

Material/材质: Aluminum / 铝 (T4.0 + 1.5 + SGCC 1.0)
Tempered Glass / 钢化玻璃 (T5.0)

HDD Support: 2 * 2.5"

PSU/电源: SFX

Motherboard/主板: MINI-ITX

PCI Slots/扩充插槽: 2

System Fan/系统风扇: 80 mm * 1 (not built-in/非标配)







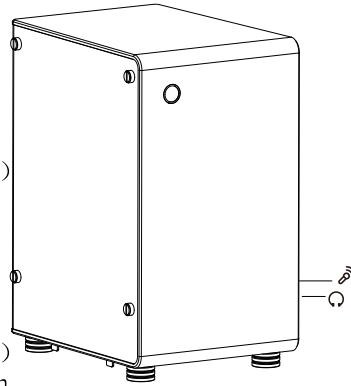







Compatibility: Length of display card/显卡长度 195mm
/ 兼容设备 Height of CPU Cooling/CPU 散热器高度 133mm

Size/尺寸: L 220mm * W 170mm * H 302mm







Weight/重量: 2.77KG

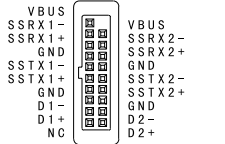
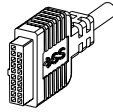
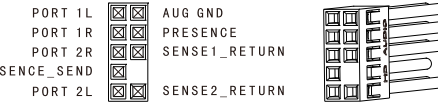
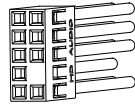
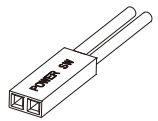

Accessory Box Instruction / 配件包说明

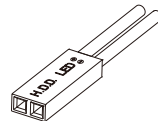
		For locking 2.5" SSD 锁 2.5" 硬盘	9PCS			Gasket 螺丝垫片 (电源、主板)	10PCS
		For locking motherboard and PSU / 锁主板及电源	9PCS			HDD Rubber Gasket 硬盘胶垫	9PCS
		For locking fan 风扇螺丝	4PCS			Buzzer 蜂鸣器	1PCS
		For binding cables 将线材束整齐	5PCS				

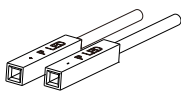
Connection Instruction / 连接说明

USB 3.0 Connection / 连接		HD AUDIO Connection / 连接	
			
Power Button Connection / 电源开关连接		Hard drive LED Connection / 硬盘灯连接	
			
Power LED Connection / 电源灯连接			
			

Schematic Diagram / 产品装机示意图

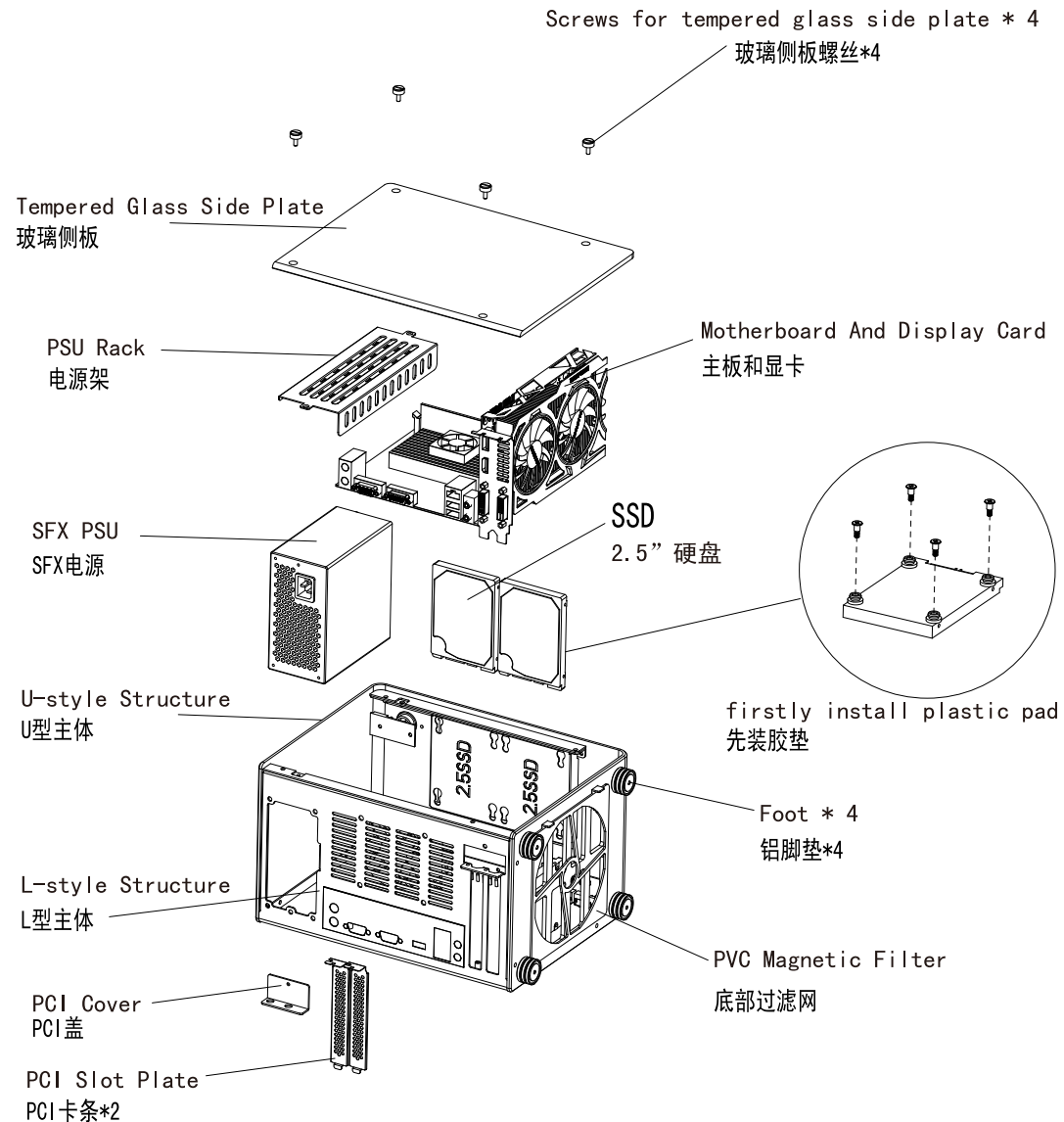

- ① Unscrew the tempered side plate screws, and then remove the tempered side plate;
- ② Unscrew 2 screws from PSU teacher, and then remove the racket;
- ③ Remove 2 pcs of PCI slot plates;
- ④ Install PSU, SSD, motherboard, display card, plug the connector, and then install tempered glass side plate step by step, assembly finished.

- ① 先将玻璃螺丝打下，取出玻璃侧板；
- ② 拧下电源架上的2颗螺丝，取出电源架；
- ③ 取出2个PCI卡条；
- ④ 依次装上电源、SSD、主板、显卡，插上接头再装回玻璃板，组装完成。