

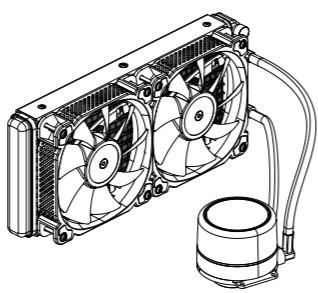

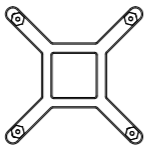

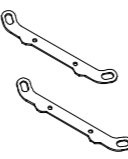
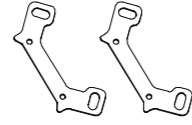
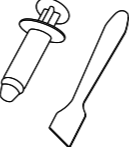

<p>A CPU Cooler CPU Kühler Ventirad CPU 쿨러 (방열기) CPU散热器</p> 		
<p>B Backplate Backplate Contre Plaque 백플레이트 背板</p> 	<p>C Intel Bracket Intel Halterung Intel Bracket 인텔 브래킷 인텔 支架</p> 	
<p>D AMD Bracket AMD Halterung AMD Bracket AMD 브래킷 AMD 支架</p> 	<p>E Thermal Paste Wärmeleitpaste Pâte thermique 써멀 페이스트 散热膏</p> 	

<p>G1 Screw Schraube Vis 나사 螺丝 x4</p> 	<p>G2 115X/1200/1700 Screw Stud 115X/1200/1700 Schraubbolzen goujon à vis 115X/1200/1700 115X/1200/1700 나사 스테드 115X/1200/1700 螺柱 x4</p> 
<p>G3 2011 Screw Stud 2011 Schraubbolzen goujon à vis 2011 2011 나사 스테드 2011 螺柱 x4</p> 	<p>G4 AMD Screw Stud AMD Schraubbolzen goujon à vis AMD AMD 나사 스테드 AMD 螺柱 x4</p> 
<p>G5 Screw Schraube Vis 나사 螺丝 x4</p> 	<p>G6 Case Screws Gehäuseschrauben Vis du boîtier 케이스 나사 机箱螺丝 x8</p> 

Step2

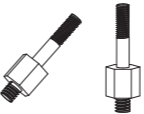

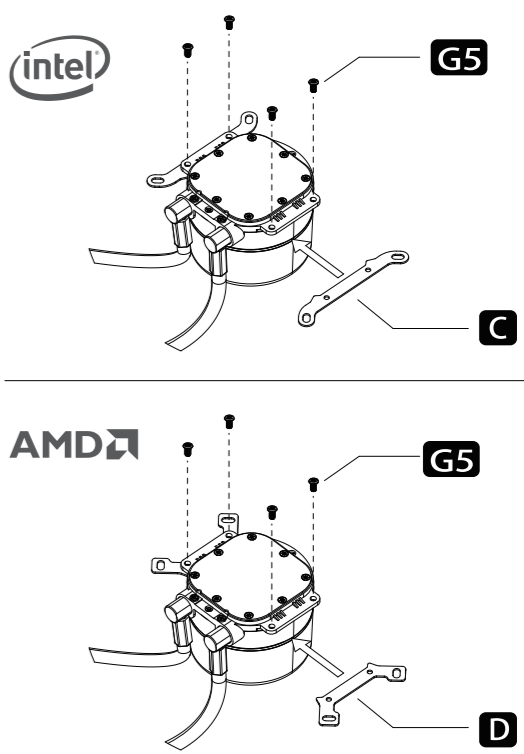
Applying thermal paste / Remove the protection film	Installing the Intel / AMD bracket
Aufbringen der wärmeleitpaste / Entfernen Sie die Schutzfolie	Installieren der Intel / AMD-Halterung
Application de la pâte thermique / Retirez le film protecteur	Installation du bracket Intel / AMD
방열 써멀구리스를 바르고 / 보호막을 뜯어 주세요	인텔 설치 / AMD 지지대
涂抹散热膏 / 取下保护膜	安装Intel / AMD 支架

Step1

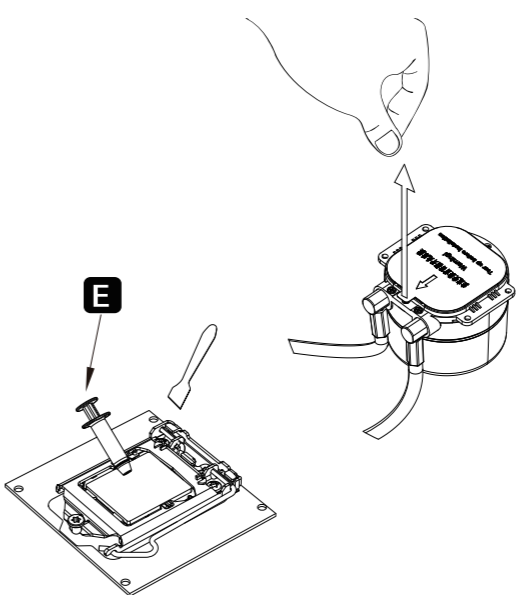



Applying thermal paste / Remove the protection film
Aufbringen der wärmeleitpaste / Entfernen Sie die Schutzfolie
Application de la pâte thermique / Retirez le film protecteur
방열 써멀구리스를 바르고 / 보호막을 뜯어 주세요
涂抹散热膏 / 取下保护膜

TW7-240
ARGB
User's Manual

© 2022 JONSBO Technology Co., Ltd. All right reserved. Specifications are subject to change without prior notice. Some trademark may be claimed as the property of others.

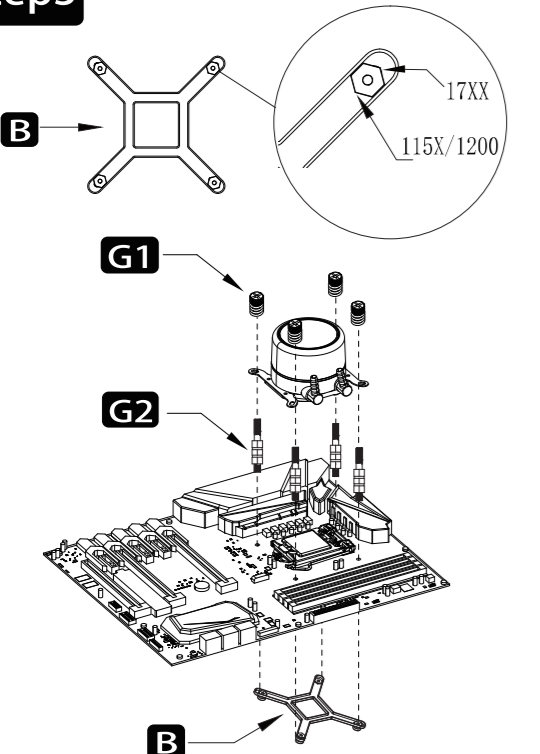
Step3



Tightening screws diagonally 

Secure the cooler -Intel LGA 115X/1200/1700
Den Kühler sichern -Intel LGA 115X/1200/1700
Fixez la glacière -Intel LGA 115X/1200/1700
고정 쿨러 (방열기) - Intel LGA 115X/1200/1700
固定散热器 -Intel LGA 115X/1200/1700

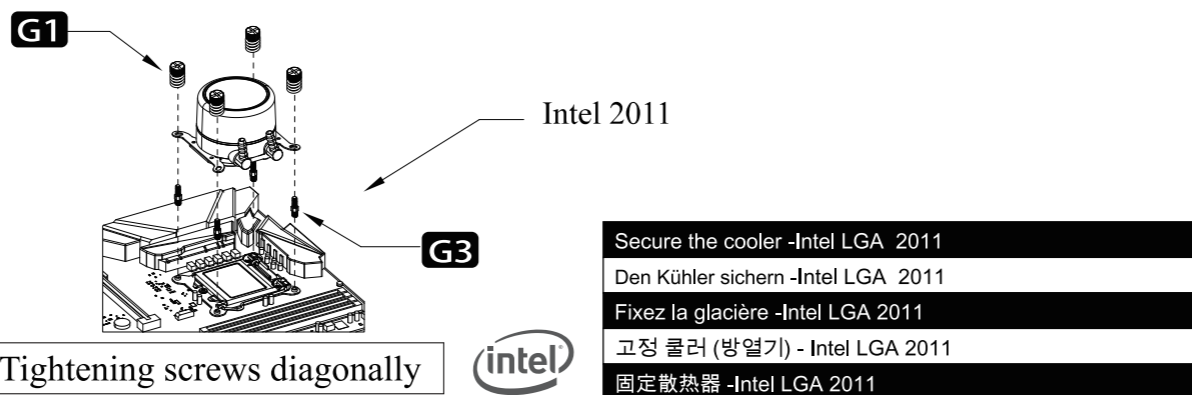

Tightening screws diagonally 

Secure the cooler -Intel LGA 2011
Den Kühler sichern -Intel LGA 2011
Fixez la glacière -Intel LGA 2011
고정 쿨러 (방열기) - Intel LGA 2011
固定散热器 -Intel LGA 2011

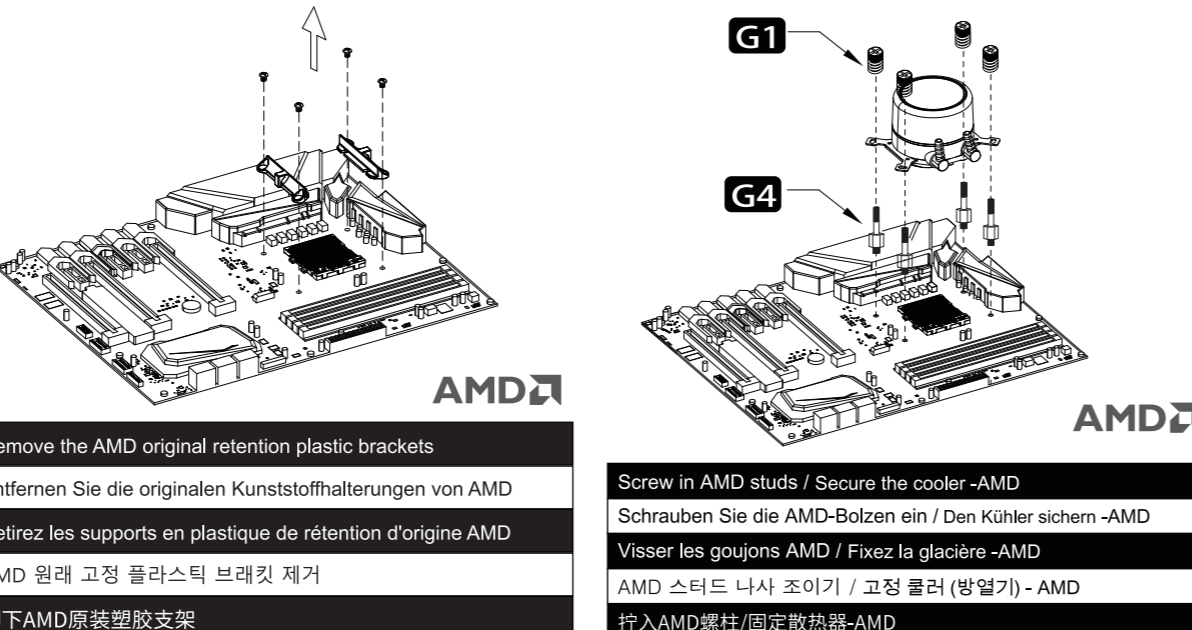

Tightening screws diagonally 

Remove the AMD original retention plastic brackets
Entfernen Sie die originalen Kunststoffhalterungen von AMD
Retirez les supports en plastique de rétention d'origine AMD
AMD 원래 고정 플라스틱 브래킷 제거
卸下AMD原装塑胶支架
Screw in AMD studs / Secure the cooler -AMD
Schrauben Sie die AMD-Bolzen ein / Den Kühler sichern -AMD
Visser les goujons AMD / Fixez la glacière -AMD
AMD 스테드 나사 조이기 / 고정 쿨러 (방열기) - AMD
拧入AMD螺柱/固定散热器-AMD

Step4

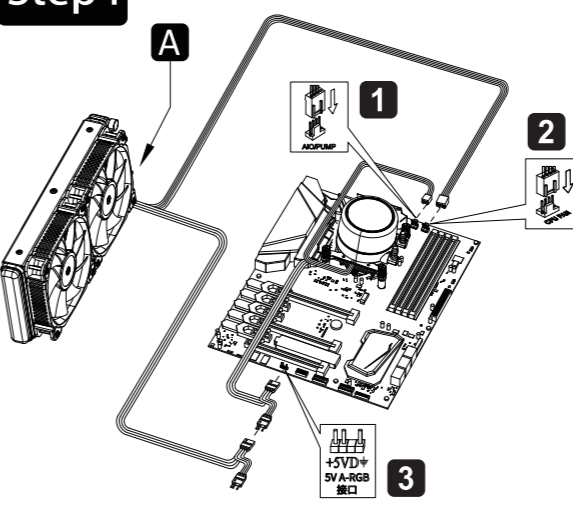

Connect the 3-pin connector from the pump unit to AIO/PUMP socket on the motherboard Verbinden Sie den 3-poligen Stecker der Pumpeneinheit mit der AIO / PUMP-Buchse auf der Hauptplatte Connectez le connecteur à 3 broches de la pompe à la prise AIO / PUMP de la carte mère 3PIN 커넥터를 메인보드 AIO/PUMP 콘센트에 연결해 주세요 冷头上3PIN供电接口连接至主板AIO/PUMP插针
Connect the 4-pin fan PWM connector to CPU_FAN socket on the motherboard Verbinden Sie den 4-poligen Lüfter-PWM-Anschluss mit der CPU_FAN-Buchse auf dem Motherboard Connectez le connecteur PWM du ventilateur à 4 broches à la prise CPU_FAN de la carte mère 4핀 팬 PWM 커넥터를 마더보드의 CPU_FAN 소켓에 연결합니다 风扇4PIN PWM供电线连接至主板CPU-FAN插针
Connect to 5V ARGB LED socket on motherboard An die 5V-ARGB-LED-Buchse auf dem Motherboard anschließen Connectez-vous à la prise LED ARGB 5V sur la carte mère 마더보드의 5V ARGB LED 소켓에 연결 连接至主板对应5V ARGB插针

Step5

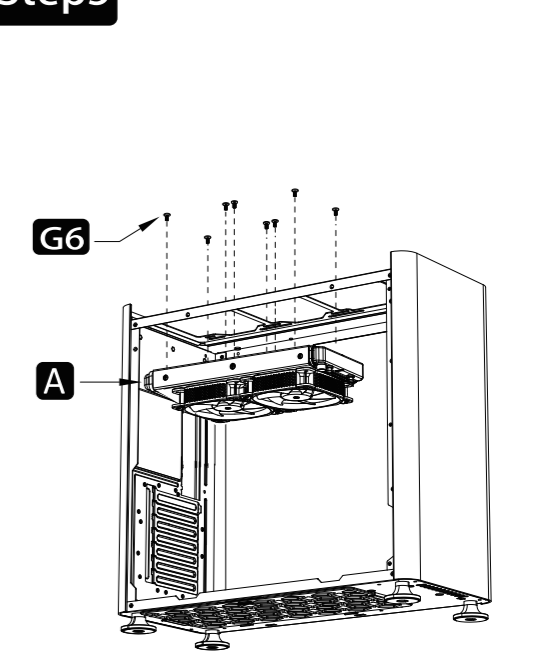

Secure the the fans and radiator
Lüfter und Kühler sichern
Ventilateur et refroidisseur sécurisés
고정 팬(FAN) 및 라디에이터(Radiator)
固定冷排至机箱