

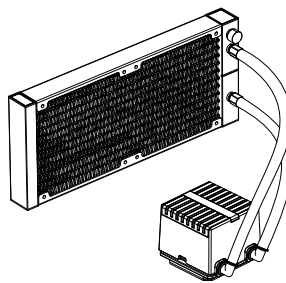

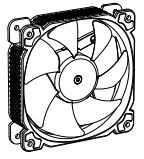

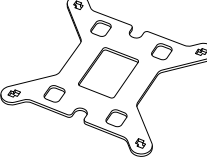

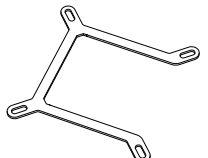
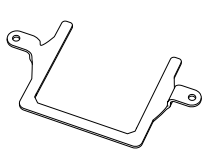

HXW-240 ARGB

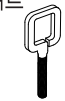
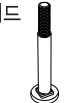
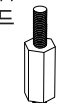
User's Manual

<p>A CPU Cooler CPU Kühler Ventirad CPU 쿨러 (방열기) CPU散热器</p> 	
<p>B Fan Ventilator Ventilateur 팬 (FAN) 风扇</p>  <p>X2</p>	<p>C Intel Backplate Intel Backplate Intel Contre Plaque 백플레이트 Intel 背板</p> 
<p>D Intel Bracket Intel Halterung Intel Bracket 인텔 브래킷 Intel 支架</p> 	<p>E AMD Bracket AMD Halterung AMD Bracket AMD 브래킷 AMD 支架</p> 

<p>F Thermal Paste Wärmeleitpaste Pâte thermique 써멀 페이스트 散热膏</p> 	<p>G1 Screw Schraube Vis 나사 螺丝 x4</p> 
<p>G2 AMD Screw stud AMD-Schraubbolzen Goujon à vis AMD AMD 나사 스테드 AMD 螺柱 x2</p> 	<p>G3 Intel Screw Stud Intel-Schraubbolzen Goujon à vis Intel 인텔 나사 스테드 Intel 螺柱 x4</p> 
<p>G4 2011 Screw Stud 2011 Schraubbolzen goujon à vis 2011 2011 나사 스테드 2011 螺柱 x4</p> 	<p>G5 Screw Stud plug Schraubverschluss bouchon à vis 나사 스테드 플러그 螺柱塞 x4</p> 
<p>G6 Screw stud spacer Bolzenabstandshalter anschrauben Entretoise de goujon à vis 나사 스테드 스페이서 螺柱高度块 x4</p> 	<p>G7 Case Screws Gehäuseschrauben Vis du boîtier 케이스 나사 机箱螺丝 x8</p> 
<p>G8 Fan Screws Lüfterschrauben Vis de ventilateur 팬 나사 风扇螺丝 x8</p> 	<p>H Y-Cable Y-Kabel Câble en Y Y-케이블선 Y-转接线</p> 

Step1

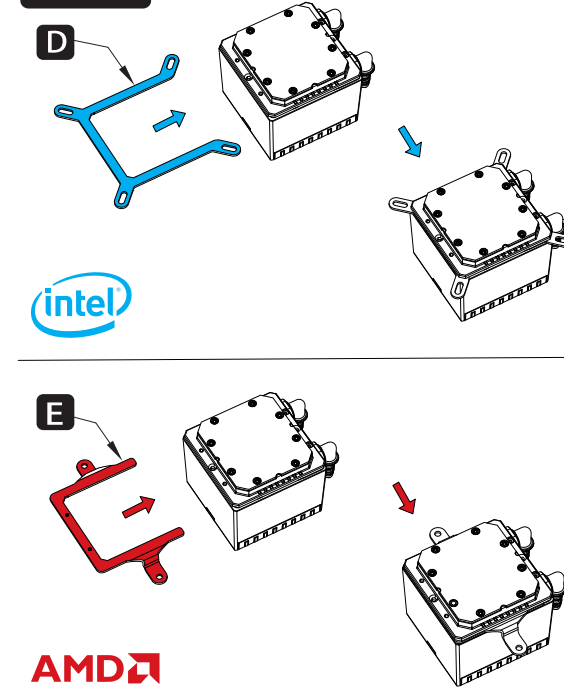

Installing the Intel / AMD bracket
Installieren der Intel / AMD-Halterung
Installation du bracket Intel / AMD
Intel 설치 / AMD 지지대
将Intel/AMD支架推入卡槽

Remove the protection film / Applying thermal paste
Entfernen Sie die Schutzfolie / Aufbringen der wärmeleitpaste
Retirez le film protecteur / Application de la pâte thermique
보호막을 뜯어 주세요 / 방열 써멀구리스를 바르고
取下保护膜 / 涂抹散热膏

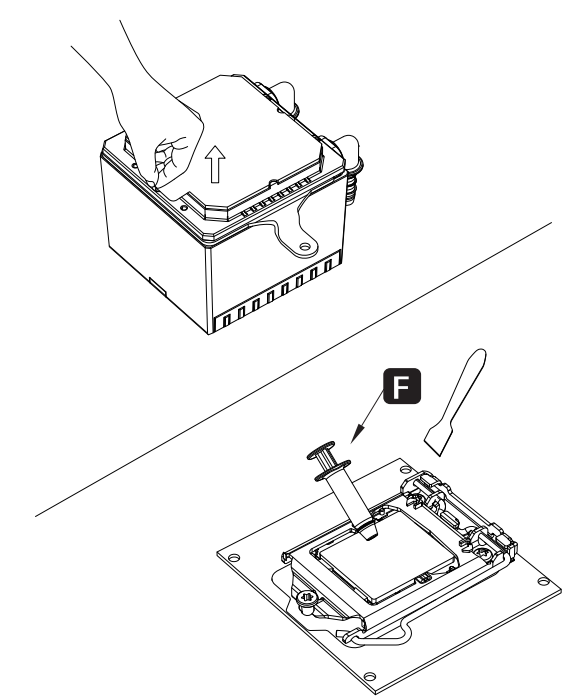

© 2022 JONSBO Technology Co., Ltd. All right reserved. Specifications are subject to change without prior notice. Some trademark may be claimed as the property of others.

Step3

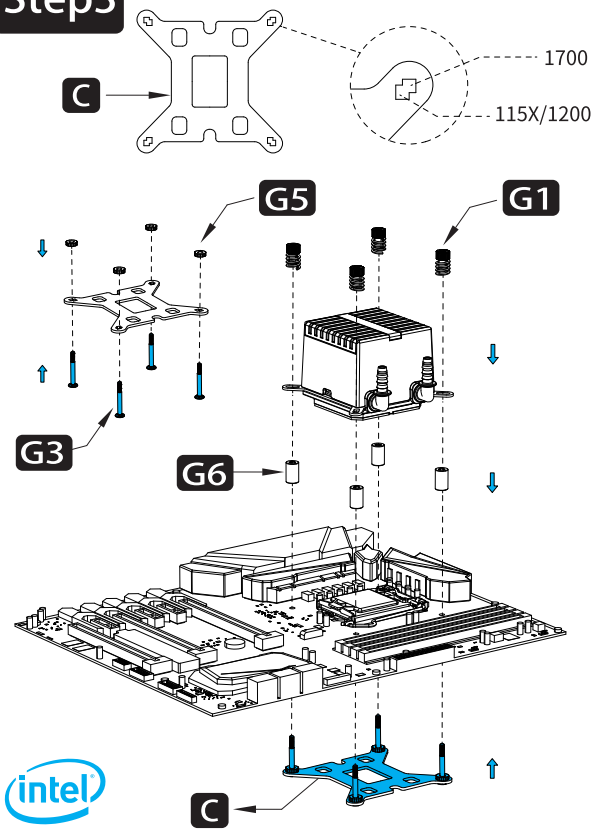

Secure the cooler -Intel LGA 115X/1200/1700
Den Kühler sichern -Intel LGA 115X/1200/1700
Fixez la glacière -Intel LGA 115X/1200/1700
고정 쿨러 (방열기) - Intel LGA 115X/1200/1700
固定散热器 -Intel LGA 115X/1200/1700

Step3.1

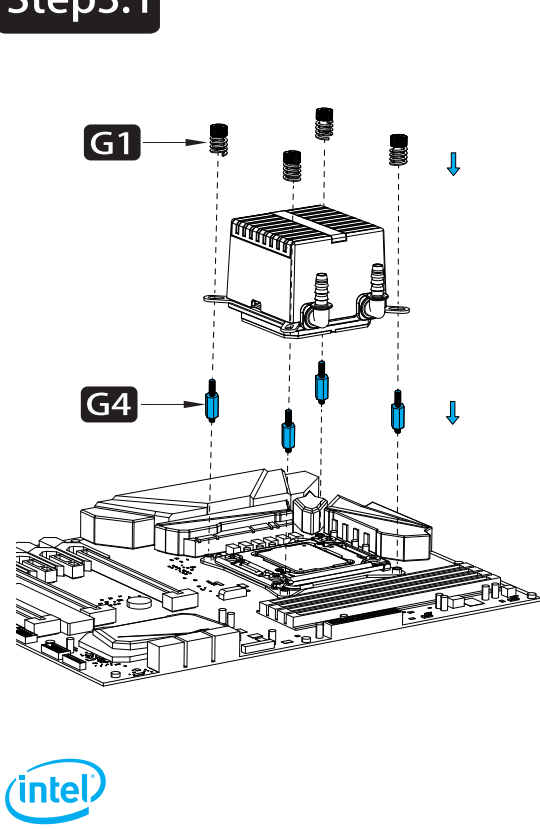

Secure the cooler -Intel LGA 2011
Den Kühler sichern -Intel LGA 2011
Fixez la glacière -Intel LGA 2011
고정 쿨러 (방열기) - Intel LGA 2011
固定散热器 -Intel LGA 2011

Step4

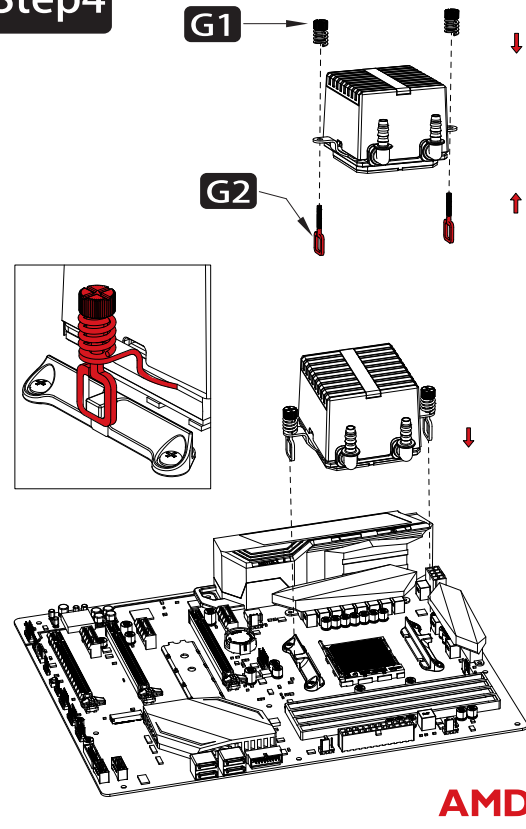

Secure the cooler -AMD
Den Kühler sichern -AMD
Fixez la glacière -AMD
고정 쿨러 (방열기) - AMD
固定散热器 -AMD

Step5

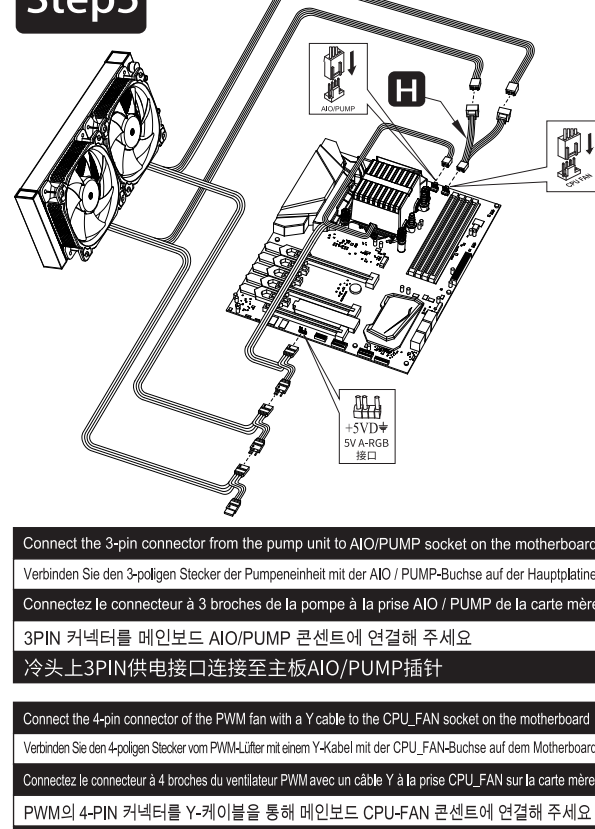

Connect the 3-pin connector from the pump unit to AIO/PUMP socket on the motherboard
Verbinden Sie den 3-poligen Stecker der Pumpeneinheit mit der AIO / PUMP-Buchse auf der Hauptplatine
Connectez le connecteur à 3 broches de la pompe à la prise AIO / PUMP de la carte mère
3PIN 커넥터를 메인보드 AIO/PUMP 콘센트에 연결해 주세요
冷头上3PIN供电接口连接至主板AIO/PUMP插针

Connect the 4-pin connector of the PWM fan with a Y cable to the CPU_FAN socket on the motherboard
Verbinden Sie den 4-poligen Stecker vom PWM-Lüfter mit einem Y-Kabel mit der CPU_FAN-Buchse auf dem Motherboard
Connectez le connecteur à 4 broches du ventilateur PWM avec un câble Y à la prise CPU_FAN sur la carte mère
PWM의 4-PIN 커넥터를 Y-케이블을 통해 메인보드 CPU-FAN 콘센트에 연결해 주세요
风扇4PIN PWM供电线通过Y线连接至主板CPU-FAN插针

Connect to 5V ARGB LED socket on motherboard
An die 5V-ARGB-LED-Buchse auf dem Motherboard anschließen
Connectez-vous à la prise LED ARGB 5V sur la carte mère
마더보드의 5V ARGB LED 소켓에 연결
连接至主板对应5V ARGB插针

Step6

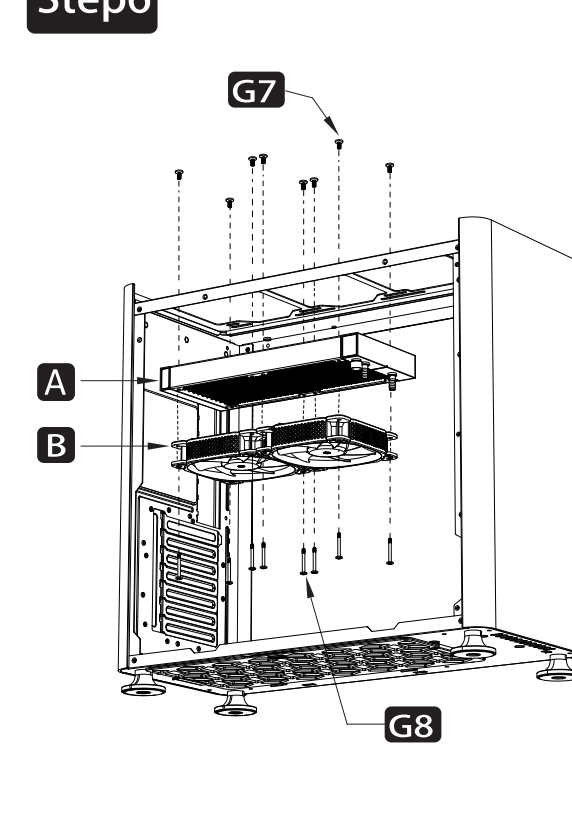

Secure the the fans and radiator
Lüfter und Kühler sichern
Ventilateur et refroidisseur sécurisés
고정 팬(FAN) 및 라디에이터(Radiator)
固定冷排至机箱