

C 3 Manual / 说明书

Specification / 产品规格:

Model/型号: C 3

Color/颜色: Silver / Black / Red / Blue

银色 / 黑色 / 红色 / 蓝色

Material/材质: Aluminum / 铝 T 1.5 + 1.2 + 1.0mm

(左右侧板、上盖、底板1.5T, 前板、后板1.2T, 其他1.0T)

HDD Support: 2 * 3.5HDD", 1 * SSD" Or/ 或者

/硬盘空间 1 * 3.5HDD", 2 * SSD"

PCI Slots/PCI数量: 4

PSU/电源: PSII(Not longer than /限长190mm)

Motherboard/主板: ITX / Micro-ATX

System Fan/系统风扇: 120mm * 1, 80mm * 2 (not built-in/非标配)

Compatibility: Length of display card/显卡长度 2.75mm

/ 兼容设备 Height of CPU Cooler/CPU 散热器高度 175mm

Size/尺寸: L 287 * W 211 * H 356 mm

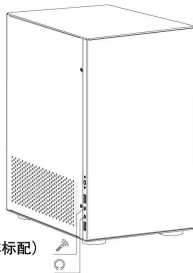

Schematic Diagram / 产品装机示意图

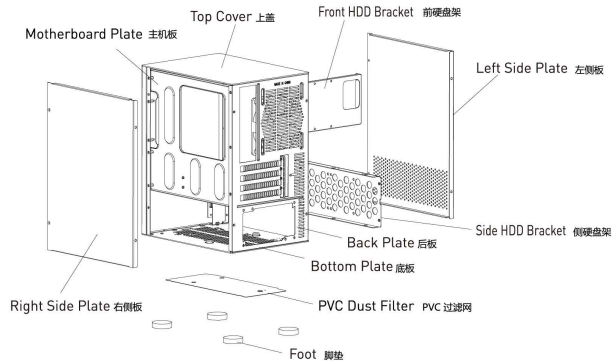

Accessories / 配件包说明

	For locking 2.5SSD 2.5SSD 硬盘螺丝	6PCS		For locking Fans 风扇螺丝	4PCS
	For locking motherboard and PSU 3.5HDD 锁主板, 电源及硬盘螺丝	17PCS		For locking 3.5HDD 3.5HDD 硬盘螺丝	4PCS
	For binding cables 绑线材料束夹	3PCS		Gasket 垫片	12PCS
	Hexagonal Stand-off 主板固定柱	1PCS			

Connectors / 连接说明

USB 3.0 Connection / 连接

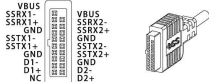

HD AUDIO Connection / 连接



Hard drive LED Connection / 硬盘灯连接

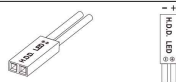

Power Button Connection / 电源开关连接

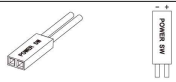

Power LED Connection / 电源灯连接

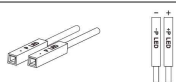

Installation Procedure For ITX Motherboard / ITX 主板推荐安装步骤

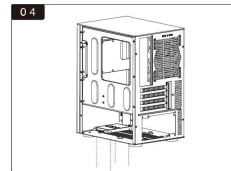
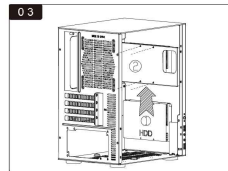
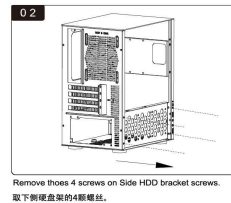
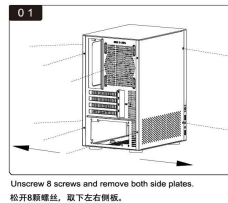

硬盘从底部装入前硬盘架再锁上螺丝。(也可以将前硬盘架再装硬盘。)

装上2.5固态硬盘。

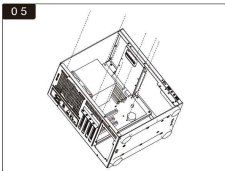

Install motherboard and lock with screws.
装上主板锁上螺丝。

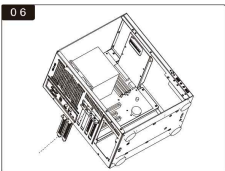

Remove the cover of the PCI slot brackets
and then take out the PCI plate.
打开PCI盖，取出PCI卡条。

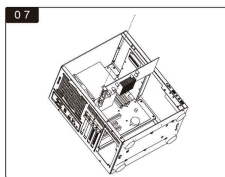

Install display card.
装上显卡。

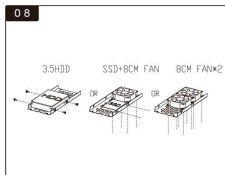

Install hardware according to your need
根据自己需要安装相应的硬件。

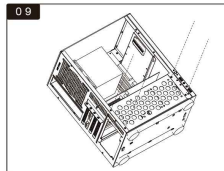

Install side HDD bracket .
装上侧硬盘架。

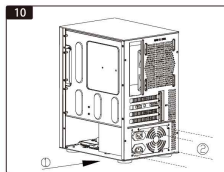

Install PSU from left side and then
lock with screws.
从左侧面装入电源，再锁上螺丝。

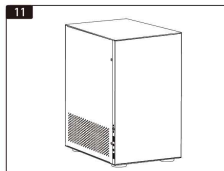

Install both side plates ,
assembly finished.
装回左右侧板，安装完成。